

MITEQ AU-1490 AMPLIFIER

FREQUENCY (MHz)	MODEL NUMBER	GAIN (dB) (Min.)	VAR. (\pm dB) (Max.)	VSWR (Max.)	IMPED. IN/OUT (Ohms)	NOISE FIGURE (dB, Typ.)	P1 dB (dBm) (Typ.)	VOLTS	NOM. DC POWER (mA)	OUTLINE NO.
1-100	AU-1490	32	0.5	2.0:1	50/50	2.9	21	15	140	3

Gain (dB)

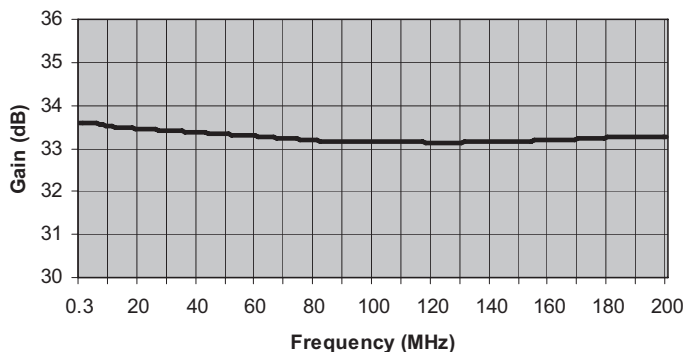

Output -1dB Gain Compression (+dBm)

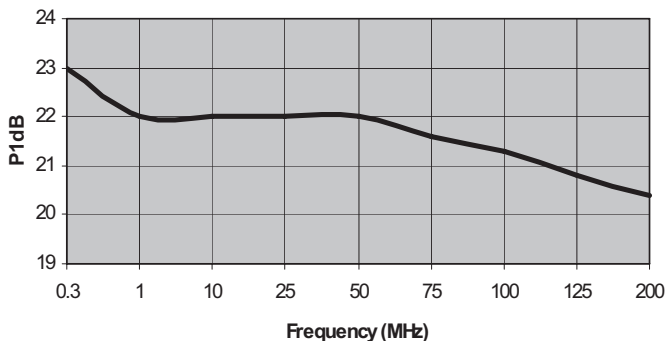

Input & Output Return Loss (dBRL)

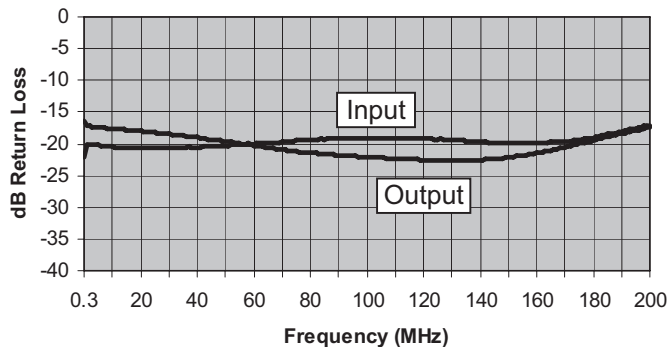

Noise Figure (dB)

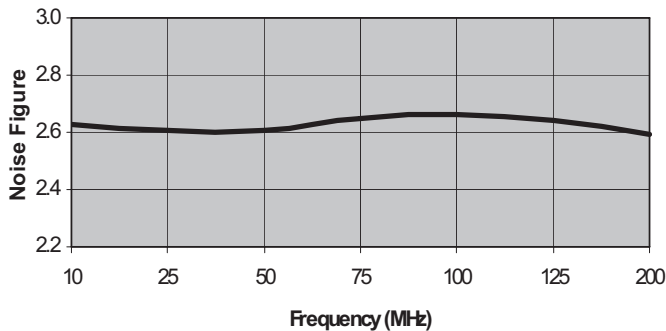

Reverse Isolation (dB)

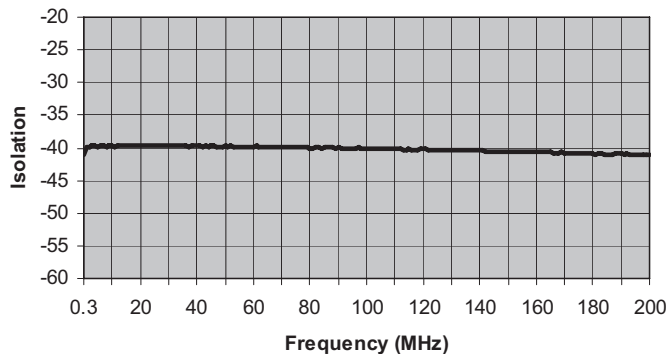

Low Frequency Gain Rolloff (dB)

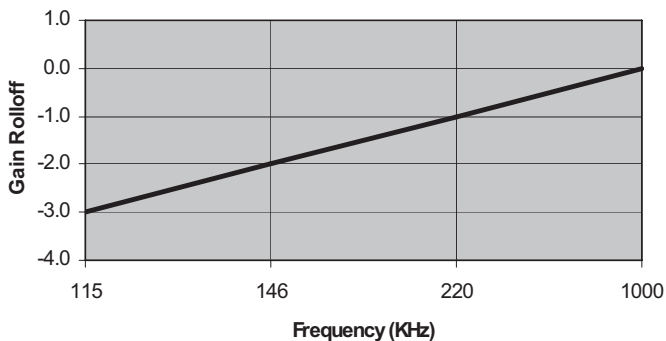

ISO 9001:2000 Certified • General Information • Warranty



100 Davids Drive, Hauppauge, NY 11788
 TEL.: (631) 439-9220 • FAX: (631) 436-7430
 e-mail: components@miteq.com • www.miteq.com

MITEQ AU-1490 AMPLIFIER

Freq. (MHz)	Gain (dB)
0.3	33.6
1	33.6
2	33.6
3	33.6
4	33.6
5	33.6
6	33.6
7	33.6
8	33.6
9	33.5
10	33.5
11	33.5
12	33.5
13	33.5
14	33.5
15	33.5
16	33.5
17	33.5
18	33.5
19	33.5
20	33.5
21	33.5
22	33.5
23	33.4
24	33.4
25	33.4
26	33.4
27	33.4
28	33.4
29	33.4
30	33.4
31	33.4
32	33.4
33	33.4
34	33.4
35	33.4
36	33.4
37	33.4
38	33.4
39	33.4
40	33.4
41	33.4
42	33.4
43	33.4
44	33.4
45	33.3
46	33.3
47	33.3
48	33.3
49	33.3
50	33.3
51	33.3
52	33.3
53	33.3
54	33.3
55	33.3
56	33.3

Freq. (MHz)	Gain (dB)
57	33.3
58	33.3
59	33.3
60	33.3
61	33.3
62	33.3
63	33.3
64	33.3
65	33.3
66	33.3
67	33.2
68	33.2
69	33.2
70	33.2
71	33.2
72	33.2
73	33.2
74	33.2
75	33.2
76	33.2
77	33.2
78	33.2
79	33.2
80	33.2
81	33.2
82	33.2
83	33.2
84	33.2
85	33.2
86	33.2
87	33.2
88	33.2
89	33.2
90	33.2
91	33.2
92	33.2
93	33.2
94	33.2
95	33.2
96	33.2
97	33.2
98	33.2
99	33.2
100	33.2
101	33.2
102	33.2
103	33.2
104	33.2
105	33.2
106	33.1
107	33.1
108	33.1
109	33.1
110	33.1
111	33.1
112	33.1
113	33.1

Freq. (MHz)	Gain (dB)
114	33.1
115	33.1
116	33.1
117	33.1
118	33.1
119	33.1
120	33.1
121	33.1
122	33.1
123	33.1
124	33.1
125	33.1
126	33.1
127	33.1
128	33.1
129	33.1
130	33.1
131	33.1
132	33.1
133	33.1
134	33.2
135	33.2
136	33.2
137	33.2
138	33.2
139	33.2
140	33.2
141	33.2
142	33.2
143	33.2
144	33.2
145	33.2
146	33.2
147	33.2
148	33.2
149	33.2
150	33.2
151	33.2
152	33.2
153	33.2
154	33.2
155	33.2
156	33.2
157	33.2
158	33.2
159	33.2
160	33.2
161	33.2
162	33.2
163	33.2
164	33.2
165	33.2
166	33.2
167	33.2
168	33.2
169	33.2
170	33.2

Freq. (MHz)	Gain (dB)
171	33.2
172	33.2
173	33.2
174	33.2
175	33.2
176	33.2
177	33.2
178	33.2
179	33.2
180	33.3
181	33.3
182	33.3
183	33.3
184	33.3
185	33.3
186	33.3
187	33.3
188	33.3
189	33.3
190	33.3
191	33.3
192	33.3
193	33.3
194	33.3
195	33.3
196	33.3
197	33.3
198	33.3
199	33.3
200	33.3



100 Davids Drive, Hauppauge, NY 11788
 TEL.: (631) 439-9220 • FAX: (631) 436-7430
 e-mail: components@miteq.com • www.miteq.com

MITEQ AU-1490 AMPLIFIER

Freq. (MHz)	Input VSWR (dBRL)	Output VSWR (dBRL)
0.3	-22	-16
1	-20	-17
2	-20	-17
3	-20	-17
4	-20	-17
5	-20	-17
6	-20	-17
7	-20	-17
8	-20	-18
9	-20	-18
10	-20	-18
11	-21	-18
12	-21	-18
13	-21	-18
14	-21	-18
15	-21	-18
16	-21	-18
17	-21	-18
18	-21	-18
19	-21	-18
20	-21	-18
21	-21	-18
22	-21	-18
23	-21	-18
24	-21	-18
25	-21	-18
26	-21	-18
27	-21	-18
28	-21	-18
29	-21	-18
30	-21	-18
31	-21	-19
32	-21	-19
33	-21	-19
34	-21	-19
35	-21	-19
36	-21	-19
37	-20	-19
38	-21	-19
39	-21	-19
40	-21	-19
41	-21	-19
42	-20	-19
43	-20	-19
44	-20	-19
45	-20	-19
46	-20	-19
47	-20	-19
48	-20	-19
49	-20	-20
50	-20	-20
51	-20	-20
52	-20	-20
53	-20	-20
54	-20	-20
55	-20	-20
56	-20	-20
57	-20	-20
58	-20	-20
59	-20	-20
60	-20	-20
61	-20	-20
62	-20	-20

Freq. (MHz)	Input VSWR (dBRL)	Output VSWR (dBRL)
63	-20	-20
64	-20	-21
65	-20	-21
66	-20	-21
67	-20	-21
68	-20	-21
69	-20	-21
70	-20	-21
71	-20	-21
72	-20	-21
73	-20	-21
74	-20	-21
75	-19	-21
76	-19	-21
77	-19	-21
78	-19	-21
79	-19	-21
80	-19	-21
81	-19	-21
82	-19	-21
83	-19	-22
84	-19	-22
85	-19	-22
86	-19	-22
87	-19	-22
88	-19	-22
89	-19	-22
90	-19	-22
91	-19	-22
92	-19	-22
93	-19	-22
94	-19	-22
95	-19	-22
96	-19	-22
97	-19	-22
98	-19	-22
99	-19	-22
100	-19	-22
101	-19	-22
102	-19	-22
103	-19	-22
104	-19	-22
105	-19	-22
106	-19	-22
107	-19	-22
108	-19	-22
109	-19	-22
110	-19	-22
111	-19	-22
112	-19	-22
113	-19	-22
114	-19	-22
115	-19	-22
116	-19	-22
117	-19	-22
118	-19	-22
119	-19	-23
120	-19	-23
121	-19	-23
122	-19	-23
123	-19	-23
124	-19	-23
125	-19	-23

Freq. (MHz)	Input VSWR (dBRL)	Output VSWR (dBRL)
126	-19	-23
127	-19	-23
128	-19	-23
129	-19	-23
130	-19	-23
131	-19	-23
132	-19	-23
133	-19	-23
134	-19	-23
135	-20	-23
136	-20	-23
137	-20	-23
138	-20	-23
139	-20	-23
140	-20	-23
141	-20	-22
142	-20	-22
143	-20	-22
144	-20	-22
145	-20	-22
146	-20	-22
147	-20	-22
148	-20	-22
149	-20	-22
150	-20	-22
151	-20	-22
152	-20	-22
153	-20	-22
154	-20	-22
155	-20	-22
156	-20	-22
157	-20	-22
158	-20	-22
159	-20	-22
160	-20	-21
161	-20	-21
162	-20	-21
163	-20	-21
164	-20	-21
165	-20	-21
166	-20	-21
167	-20	-21
168	-20	-21
169	-20	-21
170	-20	-21
171	-20	-20
172	-20	-20
173	-19	-20
174	-19	-20
175	-19	-20
176	-19	-20
177	-19	-20
178	-19	-20
179	-19	-20
180	-19	-19
181	-19	-19
182	-19	-19
183	-19	-19
184	-19	-19
185	-18	-19
186	-18	-19
187	-18	-19
188	-18	-19

Freq. (MHz)	Input VSWR (dBRL)	Output VSWR (dBRL)
189	-18	-18
190	-18	-18
191	-18	-18
192	-18	-18
193	-18	-18
194	-18	-18
195	-18	-18
196	-17	-18
197	-17	-18
198	-17	-18
199	-17	-18
200	-17	-17



100 Davids Drive, Hauppauge, NY 11788
 TEL.: (631) 439-9220 • FAX: (631) 436-7430
 e-mail: components@miteq.com • www.miteq.com

MITEQ AU-1490 AMPLIFIER

Freq. (MHz)	Reverse Isolation (dB)
0.3	-41
1	-40
2	-40
3	-40
4	-40
5	-40
6	-40
7	-40
8	-40
9	-40
10	-40
11	-40
12	-40
13	-40
14	-40
15	-40
16	-40
17	-40
18	-40
19	-40
20	-40
21	-40
22	-40
23	-40
24	-40
25	-40
26	-40
27	-40
28	-40
29	-40
30	-40
31	-40
32	-40
33	-40
34	-40
35	-40
36	-40
37	-40
38	-40
39	-40
40	-40
41	-40
42	-40
43	-40
44	-40
45	-40
46	-40
47	-40
48	-40
49	-40
50	-40
51	-40
52	-40
53	-40
54	-40
55	-40

Freq. (MHz)	Reverse Isolation (dB)
56	-40
57	-40
58	-40
59	-40
60	-40
61	-40
62	-40
63	-40
64	-40
65	-40
66	-40
67	-40
68	-40
69	-40
70	-40
71	-40
72	-40
73	-40
74	-40
75	-40
76	-40
77	-40
78	-40
79	-40
80	-40
81	-40
82	-40
83	-40
84	-40
85	-40
86	-40
87	-40
88	-40
89	-40
90	-40
91	-40
92	-40
93	-40
94	-40
95	-40
96	-40
97	-40
98	-40
99	-40
100	-40
101	-40
102	-40
103	-40
104	-40
105	-40
106	-40
107	-40
108	-40
109	-40
110	-40
111	-40

Freq. (MHz)	Reverse Isolation (dB)
112	-40
113	-40
114	-40
115	-40
116	-40
117	-40
118	-40
119	-40
120	-40
121	-40
122	-40
123	-40
124	-40
125	-40
126	-40
127	-40
128	-40
129	-40
130	-40
131	-40
132	-40
133	-40
134	-40
135	-40
136	-40
137	-40
138	-40
139	-40
140	-40
141	-40
142	-40
143	-41
144	-41
145	-41
146	-41
147	-41
148	-41
149	-41
150	-41
151	-41
152	-41
153	-41
154	-41
155	-41
156	-41
157	-41
158	-41
159	-41
160	-41
161	-41
162	-41
163	-41
164	-41
165	-41
166	-41
167	-41

Freq. (MHz)	Reverse Isolation (dB)
168	-41
169	-41
170	-41
171	-41
172	-41
173	-41
174	-41
175	-41
176	-41
177	-41
178	-41
179	-41
180	-41
181	-41
182	-41
183	-41
184	-41
185	-41
186	-41
187	-41
188	-41
189	-41
190	-41
191	-41
192	-41
193	-41
194	-41
195	-41
196	-41
197	-41
198	-41
199	-41
200	-41



100 Davids Drive, Hauppauge, NY 11788
 TEL.: (631) 439-9220 • FAX: (631) 436-7430
 e-mail: components@miteq.com • www.miteq.com

MITEQ AU-1490 AMPLIFIER

OUTLINE	DIM A	DIM B	OUNCES
3	2.74 [69.60]	2.54 [64.52]	2.9

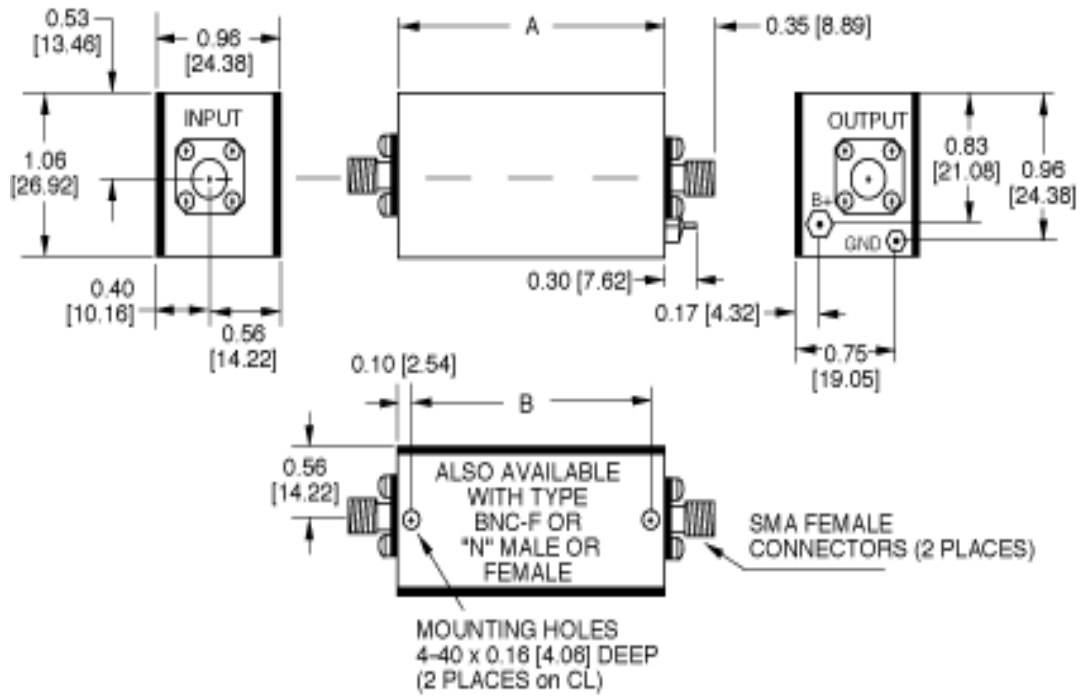

NOTE: DIMENSIONS ARE IN INCHES [MILLIMETERS].



100 Davids Drive, Hauppauge, NY 11788
 TEL.: (631) 439-9220 • FAX: (631) 436-7430
 e-mail: components@miteq.com • www.miteq.com

OPTIONS FOR BIPOLAR AMPLIFIERS

INPUT BIAS TEE

Add Suffix “-F”

Used to inject bias signal to photo diode or other type of device. Check for availability on your model before ordering. Available on most units operating above 1 MHz. Please contact MITEQ with your custom requirements.

BIAS THROUGH THE OUTPUT CONNECTOR

Add Suffix “-1306/E” or “-1306/D”

Used to supply operating power when the amplifier is remotely located while eliminating the need to run a separate DC line. Specify whether existing power pin should be “Enabled” or “Disabled.” To order, add -1306/E or -1306/D after model number. Example: AU-2A-0150-1306/E will have existing +15 V pin enabled so that it can be used as a test point. Use caution with this option since any voltage applied here will also be present on the RF output center pin. Available on most units operating above 1 MHz.

BIAS THROUGH THE OUTPUT CONNECTOR WITH DC FEEDTHROUGH TO RF INPUT

Add Suffix “-1334/E” or “-1334/D”

Used to supply operating power when the amplifier is remotely located and eliminates the need to run a separate DC line. This DC voltage is then internally fed to the RF input to power a remote LNA or other low power equipment. Maximum current of external load will vary with model type. Available on most units operating above 1 MHz. Please contact factory prior to ordering.

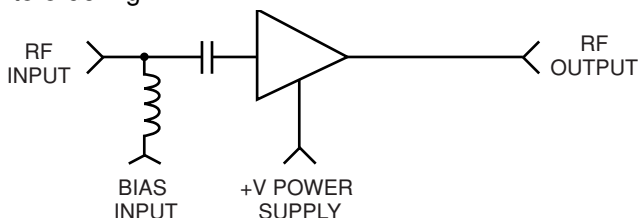

Specify whether existing power pin should be “Enabled” or “Disabled”. To order, add “-1334/E” or “-1334/D”

after model number. Example: AU-2A-0150-1334/E will have existing +15 V pin enabled so that it can be used as a test point. Use caution with this option since any voltage applied here will also be present on both the RF output and input center pins.

TYPE N OR BNC CONNECTORS

Add Suffix “-N” or “-BNC”

Type N-female and type BNC-female are available for all outlines 1 through 5, 12, 13 and 15 amplifiers. Add connector type after model number. Examples: AU-2A-0150-N; AU-2A-0150-BNC. Type N-male and mixed connector types are also available on request. Please call MITEQ with your specific requirements.

INPUT INTERNAL LIMITER

Add Suffix “-1103”

Available on models up to 500 MHz. Will protect the input stage from CW signals as high as +30 dBm. To order, add “-1103” after model number. Example: AU-2A-0150-1103. Options are available for protection against short duration pulses up to 50 W.

AC POWER SUPPLY (100 to 240 VAC, 47 - 440 Hz). Add Suffix “-1179”

Available as an add-on to most models using outlines 1 through 5 and 15. Includes 6-foot line cord with standard US line plug, internal fuse, on/off switch and LED indicator light. Amplifier is permanently mounted to power supply. To order, add “-1179” after model number. Example: AU-2A-0150-1179. Refer to outline 12 for dimensions.

AC POWER SUPPLY (Wall plug-in unit) Part Number “205531-19”

A low cost alternate to option “-1179”, the wall plug-in unit is a small switching power supply capable of delivering 1 amp at 15 volts.

AC POWER SUPPLY WITH SMC CONNECTORS (Wall plug-in unit) Part Number “-1179SC”

Same as above except has mating SMC connectors on amplifier DC input and power supply DC output. Available for outlines 1 through 10, 13 and 15.

ADDITIONAL OPTIONS AVAILABLE

OPTION	SUFFIX
Gain Window	-GW
Phase Match	-PM
Amplitude Match	-AM
Gain Control	-GC



100 Davids Drive, Hauppauge, NY 11788
TEL.: (631) 439-9220 • FAX: (631) 436-7430
e-mail: components@miteq.com • www.miteq.com

GENERAL INFORMATION

PRICING AND TERMS

A quotation on any item in the catalog is available by contacting the factory. All quotations, unless otherwise noted, are valid for 60 days from the date of issue, F.O.B. (FCA) Hauppauge, NY 11788. Pricing does not include customer or government source inspection unless otherwise noted. On international orders, an irrevocable letter of credit may be required. MITEQ accepts these credit cards:



QUANTITY DISCOUNTS

A quantity discount is generally available on most catalog items. Due to the wide variety of devices in the catalog, it is not possible to provide a standard discount schedule. When quantities are involved, please contact the factory and the appropriate information will be provided.

SOURCE INSPECTION

Government / customer source inspection is available on any item upon receipt of the complete written confirmation of purchase order items, including the prime government contract number. Source inspection with respect to some products increases the unit price and extends delivery because of duplicate standard final inspection and testing. It is recommended wherever possible that a Certificate of Compliance be substituted for source inspection to minimize price and delivery delays.

SHIPPING INFORMATION

Unless instructed otherwise by the customer, we will ship UPS in the U.S. F.O.B. (FCA) Hauppauge. Air freight will be used as the primary international means of shipment. Please indicate at time of purchase what method of shipment you require.

RETURNED MATERIAL

When returning material for repair or replacement, please ensure that there is complete information included with the shipment, giving a detailed description of the reason for its return, the date and purchase order on which it was obtained, and the exact address to which the material is to be reshipped. All returns must arrive freight, postage, duties and handling prepaid.

REPAIR COSTS

Warranty repairs will be made at no cost to the customer. Units out of warranty, or those which have been mishandled, will require approval by the customer for the charges involved before the repairs can be accomplished. We will provide an estimate for the cost of the repair, which can be applied to the repair, if approval is granted. For those items that are deemed beyond repair, or where the customer may decide not to repair the unit, an evaluation fee and handling charge will be applicable.

APPLICATION ENGINEERING

We maintain a large support staff of engineers who are experts in specific areas of microwave technology. Each has an engineering background that combines both a formal engineering education with training and experience in product design. As further technical support, we make available the services of our engineering and scientific staff, who may be consulted on more advanced circuit designs or application problems.

DRAWINGS AND SPECIFICATIONS

The material presented in this catalog was current at the time of publication. MITEQ Inc.'s continuing product improvement program makes it necessary to reserve the right to change our mechanical and electrical specifications without notice. If either of these parameters is critical, please contact the factory to verify that the information is current.

ADDITIONAL INFORMATION

WARRANTY

ISO 9001:2000 Certified



MITEQ FEDERAL SUPPLY CODE

Our Federal Supply Code is: 33592



100 Davids Drive, Hauppauge, NY 11788
TEL.: (631) 439-9220 • FAX: (631) 436-7430
e-mail: components@miteq.com • www.miteq.com