

1 TO 4 GHz IMAGE REJECTION OR I/Q MIXERS

MODELS: IR0104LC1A, IR0104LC1B, IR0104LC1C AND IR0104LC1Q

FEATURES

- RF/LO coverage 1 to 4 GHz
- IF operation DC to 0.5 GHz
- Conversion loss 8 dB typical
- Image rejection 20 dB typical

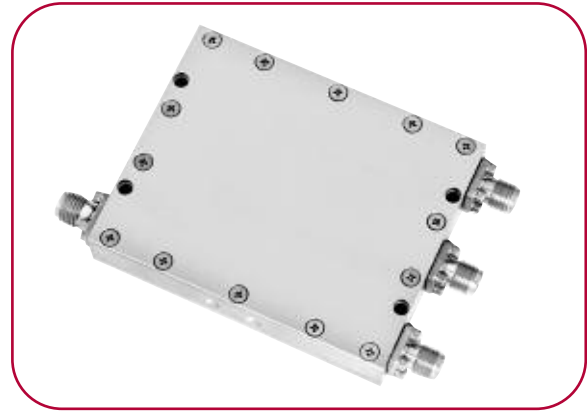

ELECTRICAL SPECIFICATIONS

INPUT PARAMETERS	CONDITION	UNITS	MIN.	TYP.	MAX.
RF frequency range		GHz	1		4
RF VSWR (RF = -10 dBm)		Ratio		2:1	
LO frequency range		GHz	1		4
LO power range	IR0104LC1	dBm	+10	+12	+13
	IR0104MC1	dBm	+13	+15	+16
	IR0104HC1	dBm	+17	+18	+20
LO VSWR		Ratio		2.5:1	
TRANSFER CHARACTERISTICS	CONDITION	UNITS	MIN.	TYP.	MAX.
Conversion loss (Note 1)	RF > LO	dBm		8	9.5
	IR0104LC1Q	dB		11	12.5
Single-sideband noise figure		dB		10	
Image rejection (Note 1)	RF < LO	dB	18	20	
LO-to-RF isolation		dB	18	20	
LO-to-IF isolation		dB		20	
Input power at 1 dB compression	IR0104LC1	dBm		+6	
	IR0104MC1	dBm		+10	
	IR0104HC1	dBm		+15	
Input two-tone third-order intercept point	IR0104LC1	dBm		+16	
	IR0104MC1	dBm		+20	
	IR0104HC1	dBm		+25	
Amplitude balance	IR0104LC1Q	dB			±1.5
Phase balance	IR0104LC1Q	Degrees			±12.5
Truth table	IR0104LC1Q		PORT	RF < LO	RF > LO
			I	0	-90
			Q	-90	0
OUTPUT PARAMETERS	CONDITION	UNITS	MIN.	TYP.	MAX.
IF frequency (image rejection mode)	IR0104LC1A	MHz	20		40
	IR0104LC1B	MHz	40		80
	IR0104LC1C	MHz	100		200
IF frequency (QIFM, I/Q demodulator mode)	IR0104LC1Q	MHz	DC		500
IF VSWR (IF = -10 dBm)		Ratio		1.5:1	

IR0104LC1C TYPICAL TEST DATA

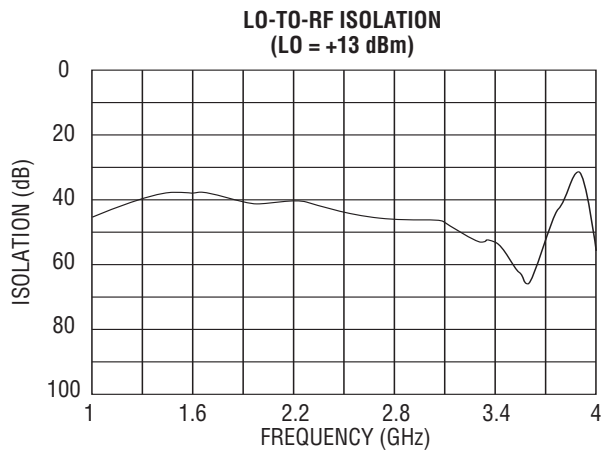
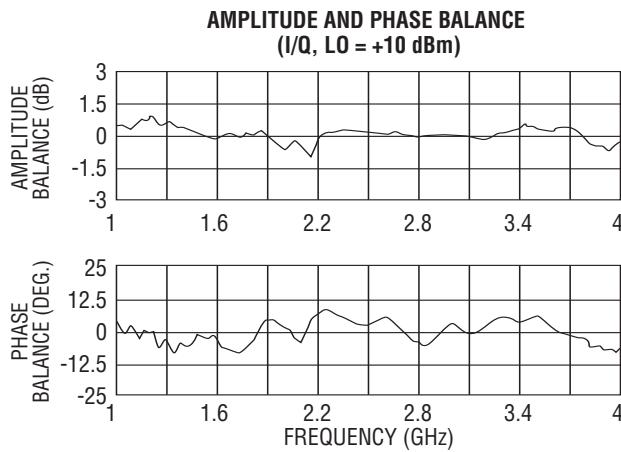
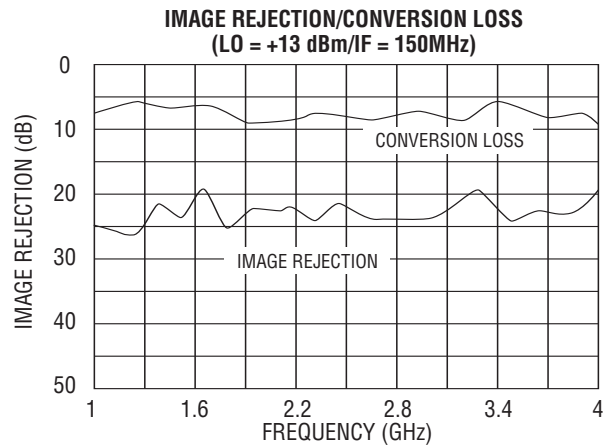
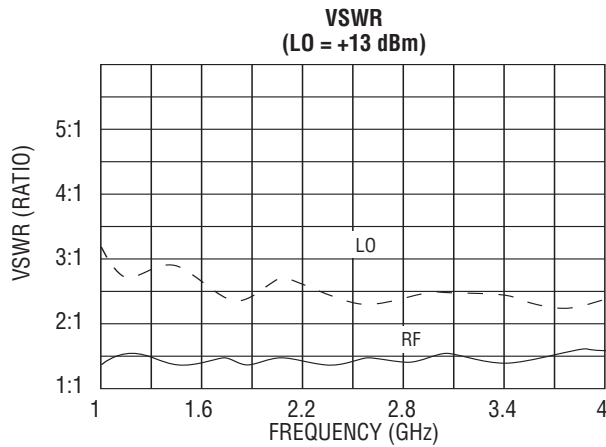

MAXIMUM RATINGS

Specification temperature..... +25°C
 Operating temperature -54 to +85°C
 Storage temperature -65 to +125°C

GENERAL NOTE

1. Standard catalog unit aligned and tested for guaranteed RF > LO performance. RF < LO guaranteed performance is available, please contact MITEQ.

NOTE: Test data supplied at 25°C; conversion loss, LO-to-RF isolation, image rejection (IF Options A, B and C), phase and amplitude balance (IF Option Q).

OUTLINE DRAWINGS

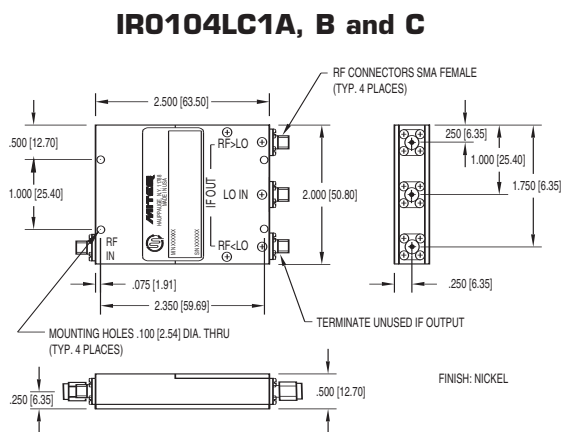
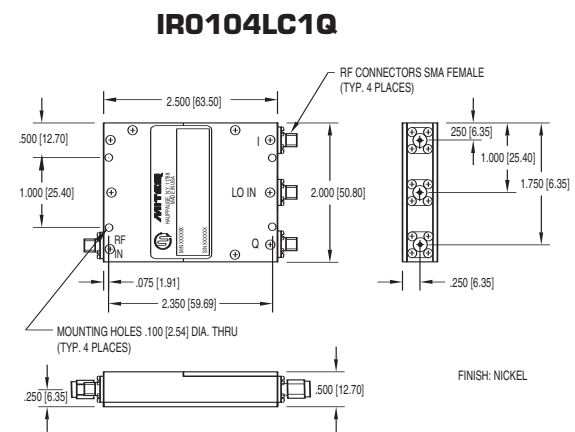

IMAGE REJECTION



QIFM, I/Q DEMODULATOR

NOTE: All dimensions shown in brackets [] are in millimeters.

