

DASH NO.	APPLICATION		REVISIONS			
	NEXT ASSY	USED ON	LTR	DESCRIPTION	DATE	APPROVED
			C	Incorporated ECN 12489	06/03/09	<i>EJ Marty</i>
142051						

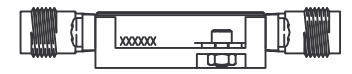

ACTUAL SIZE

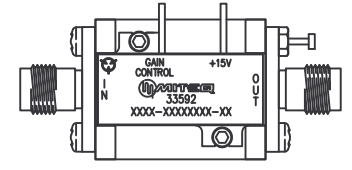
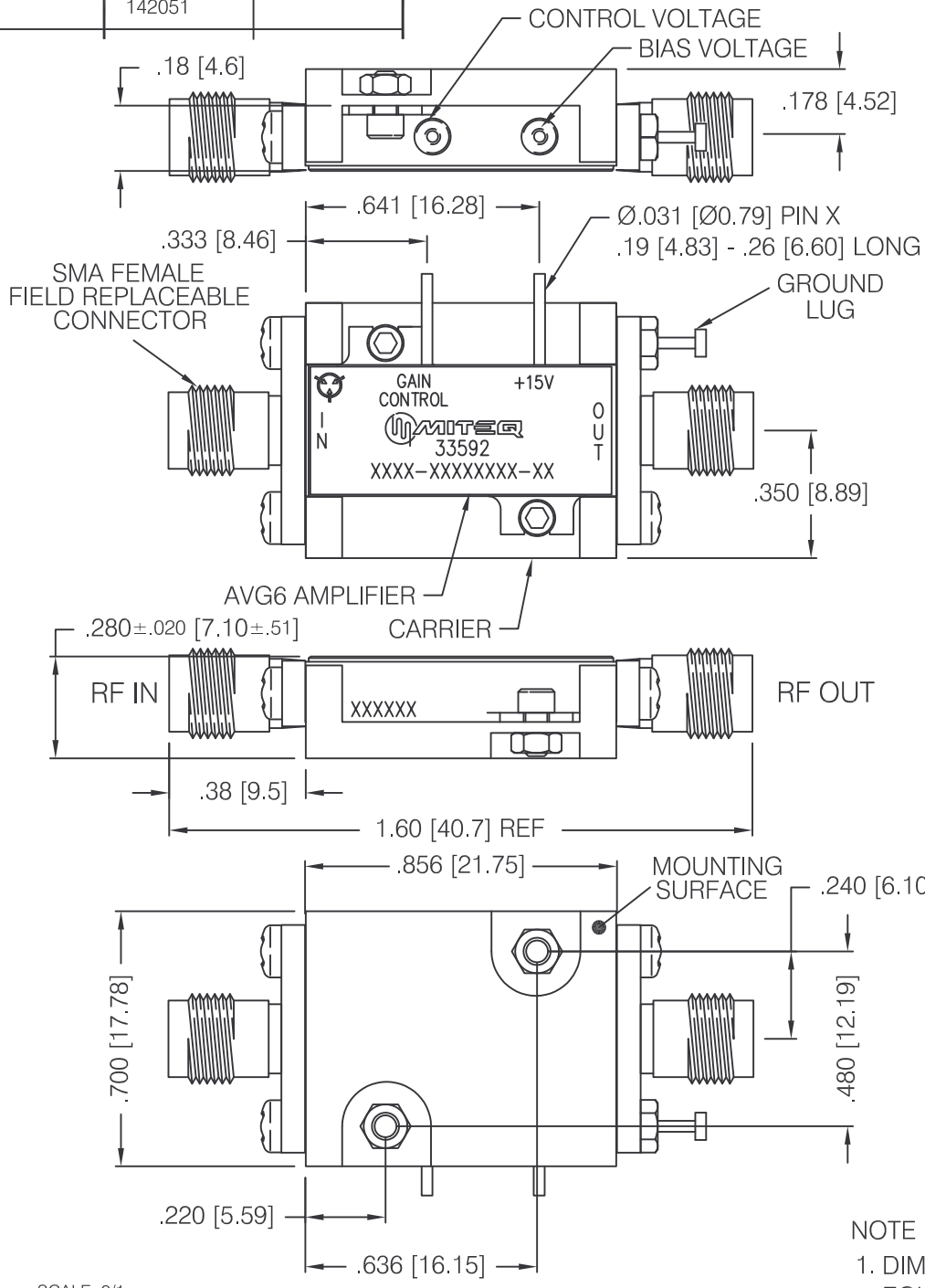
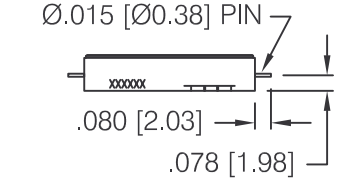
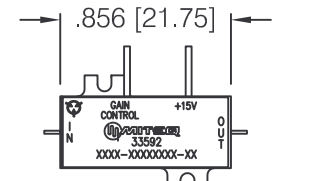

ACTUAL SIZE SHOWN AS DROP IN

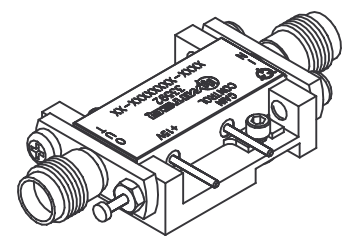

NOTE
1. DIMENSIONS IN BRACKETS ARE METRIC EQUIVALENTS

SCALE: 2/1

UNLESS OTHERWISE SPECIFIED DIMENSIONS ARE IN INCHES TOLERANCES ON	NAME	DATE	 100 Davids Drive, Hauppauge, New York 11788			
	DWN BY RayS	06/18/01				
	DECIMAL .XX ±.01 DECIMAL .XXX ±.005 ANGLES X° ±30'	CHK BY <i>EJ Marty</i>	06/03/09	6 STAGE AVG AMPLIFIER OUTLINE		
AMPLIFIER - KOVAR CARRIER - ALUM	PROJ ENGR <i>N. Shaikh</i>	06/03/09	SIZE A			
	SECT HEAD		SCALE	PROJECT	SHEET 1 OF 1	
	Q.C.					
	CUST					